

Sunbeam

MINI BARISTA ESPRESSO MACHINE

User Guide

EM4300



Contents

Sunbeam's Safety Precautions	1
Features of your Sunbeam Mini Barista	2 - 4
Before First Use of the Mini Barista Espresso Machine	5
Coffee Making Guide for the Mini Barista Espresso Machine	6 - 9
Tips for Making the Perfect Cup	10 - 11
Tips for Milk Texturing	12 - 13
Coffee Styles to Try	14 - 15
Shot Volume Programming	16 - 17
Care & Cleaning	18 - 19
Descaling: Group Head & Steam Wand	20 - 21
Troubleshooting Guide	22 - 23
Warranty	24
Espresso Machine Accessories Available for Purchase	25

Important Instructions - retain for future use

تأكد من تفهم احتياطات السلامة المذكورة اعلاه

請務必理解上述的安全預防措施。

Assurez-vous que les précautions ci-dessus relatives à la sécurité sont bien comprises

Versichern Sie sich, dass die obenstehenden Sicherheitsmaßnahmen Verstanden werden

Βεβαιώστε πως οι παραπάνω προφυλάξεις ασφαλείας γίνονται κατανοητές

Pastikan bahwa tindakan-tindakan keselamatan seperti di atas dimengerti anda

Accertatevi che le suddette norme di sicurezza siano comprese a dovere

上記の注意事項をよくお読みになり、安全を御確認ください

Уверете се дека погоре споменатите мерки на претпазливост се добро разбрани

Asegúrese de que las precauciones de seguridad precedentes sean bien comprendidas

کاری بکنید کہ احتیاط‌های بالا حتماً درک بشوند

ต้องแน่ใจว่า ข้อควรระวังเรื่องความปลอดภัยข้างต้น เป็นที่เข้าใจกันดี

Yukarda belirtilen güvenlik önlemlerinin anlaşıldığınızı emin olunuz

Xin kiểm chắc rằng những biện pháp làm an toàn kể trên được hiểu rõ

Sunbeam's Safety Precautions

SAFETY PRECAUTIONS FOR YOUR SUNBEAM ESPRESSO MACHINE

- Always place the unit on a flat, level surface.
- Do not operate without water in reservoir. Fill reservoir with only clean and cold water. Observe the maximum filling volume is 2 litres.
- Do not remove the Group Handle during the espresso pour or water flow as the unit is under pressure. Removing the Group Handle during either of these operations can lead to a scalding or injury.
- The Steam & Hot Water Wand becomes very hot during texturing milk and water flow. This may cause burns in case of contact, therefore avoid any direct contact with the wand.
- Always disconnect the plug from the power outlet prior to cleaning the espresso machine or if there is any problem during the coffee making process.
- Do not allow the Power Cord to come into contact with the hot parts of the espresso machine, including the Cup Warming Plate and the Steam & Hot Water Wand.
- Do not place hands directly under the steam, hot water or espresso pour as this can lead to a scalding or injury.
- The temperature of accessible surfaces may be high when the appliance is operating. Even after use, the heating element surface is subject to residual heat after use.
- Do not use an appliance for any purpose other than its intended use. Injury could occur from misuse.
- Cleaning and user maintenance shall not be made by children without supervision.
- Do not place in a cabinet when in use.

Sunbeam is very safety conscious when designing and manufacturing consumer products, but it is essential that the product user also exercise care when using an electrical appliance. Listed below are precautions which are essential for the safe use of an electrical appliance:

- Read carefully and save all the instructions provided with an appliance.
- Always turn the power off at the power outlet before you insert or remove a plug. Remove by grasping the plug - do not pull on the cord.
- Turn the power off and remove the plug when the appliance is not in use and before cleaning.
- Do not use your appliance with an extension cord unless this cord has been checked and tested by a qualified technician or service person.
- Always use your appliance from a power outlet of the voltage (A.C. only) marked on the appliance.
- This appliance is not intended for use by persons (including children) with reduced physical, sensory or mental capabilities, or lack of experience and knowledge, unless they have been given supervision or instruction concerning use of the appliance by a person responsible for their safety.
- Children should be supervised to ensure that they do not play with the appliance.
- The temperature of accessible surfaces may be high when the appliance is operating.
- Never leave an appliance unattended while in use.
- Do not use an appliance for any purpose other than its intended use.
- Do not place an appliance on or near a hot gas flame, electric element or on a heated oven.
- Do not place on top of any other appliance.
- Do not let the power cord of an appliance hang over the edge of a table or bench top or touch any hot surface.
- Do not operate any electrical appliance with a damaged cord or after the appliance has been damaged in any manner. If damage is suspected, return the appliance to the nearest Sunbeam Appointed Service Centre for examination, repair or adjustment.
- For additional protection, Sunbeam recommend the use of a residual current device (RCD) with a tripping current not exceeding 30mA in the electrical circuit supplying power to your appliances.
- Do not immerse the appliance in water or any other liquid unless recommended.
- Appliances are not intended to be operated by means of an external timer or separate remote control system.
- This appliance is intended to be used in household and similar applications such as: staff kitchen areas in shops, offices and other working environments; farm houses; by clients in hotels, motels and other residential type environments; bed and breakfast type environments.

If you have any concerns regarding the performance and use of your appliance, please visit the Sunbeam Website or contact Sunbeam Consumer Care - details are on the back page.

Ensure the above safety precautions are understood.

Features of your Sunbeam Mini Barista

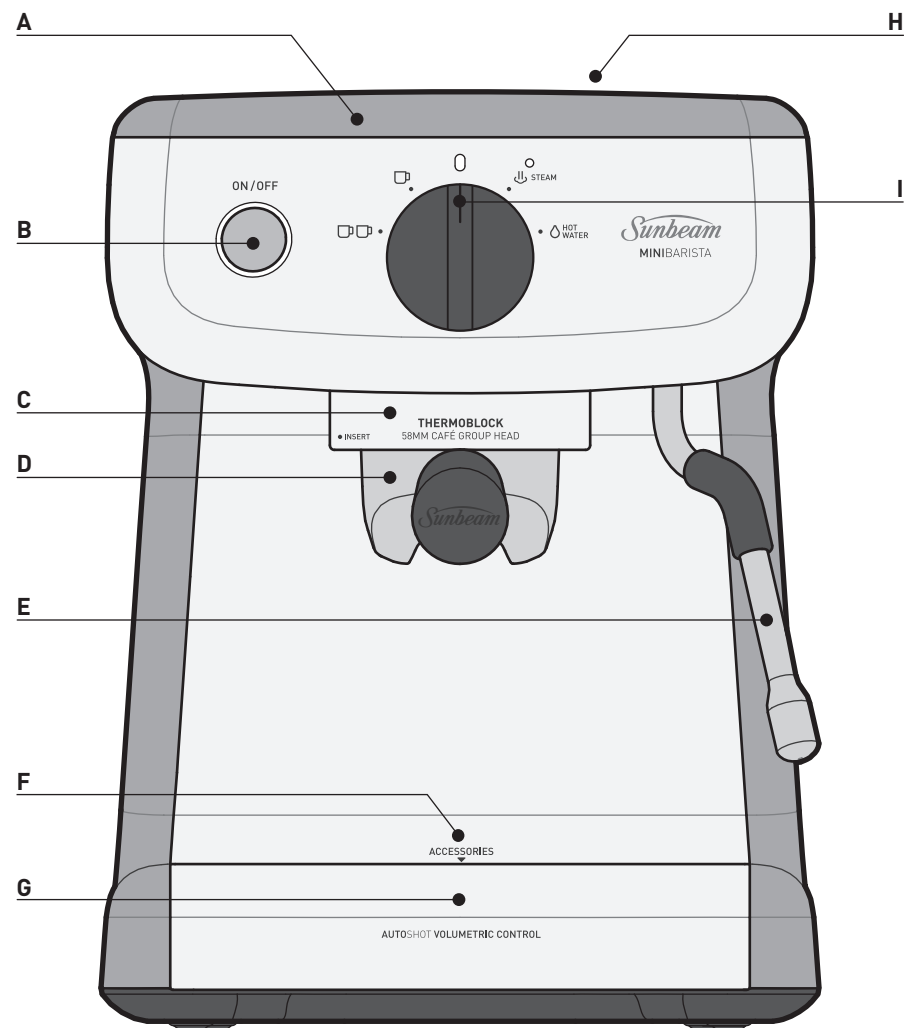

Steam Wand Pin
 Dual Wall Filter Basket Pin

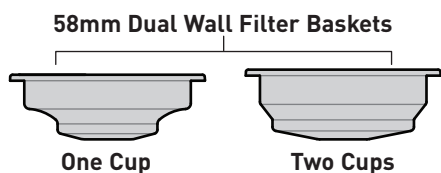
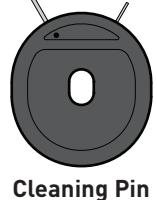

Features of your Sunbeam Mini Barista

A. Warming Plate with Tamper Home

Preheat cups and glasses which helps retain the essential characteristics of true espresso; aroma and a rich, sweet taste.

B. ON/OFF Button & Light

The ON/OFF LIGHT will illuminate & pulse to indicate it is warming up. The ON/OFF LIGHT stays fully illuminated when ready. The machine will go to sleep after 20 mins, the ON/OFF LIGHT is off.

C. Group Head - 58mm Commercial Size

The larger size accepts more grinds, so you can have a true café tasting coffee at home.

D. Group Handle - 58mm Commercial Size

The wide size used in cafés for a more even water flow & improved extraction taste.

E. Steam and Hot Water Wand

Ball joint movement with silicone cover, so you can move the wand to your desired position without burning your fingers.

F. Accessories Storage Home

Area behind the Drip Tray, for storing the One & Two Cup Filter Baskets & the Cleaning Pin.

G. Removable Drip Tray & Grill

Includes a Water Level Indicator which floats through the Grill indicating when the tray is full and requires emptying.

H. Removable 2L Water Reservoir

Push back the Lid & fill with room temperature water, or remove the Water Reservoir by opening the Lid, & lifting upwards using the Handle located inside.

I. Dial with Auto Shot Control

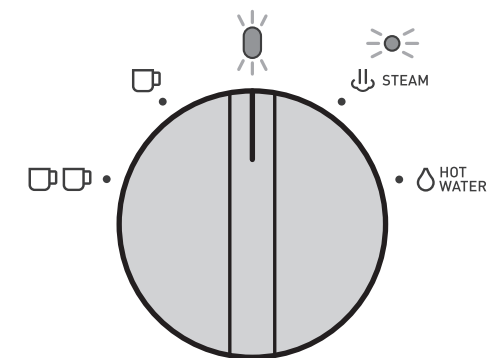

Ready Light

Fully illuminated when ready.
 Flashes when DIAL needs to be returned to the vertical position.



One Cup

Pours 1 Shot Espresso - 30mL then automatically stops.



Two Cup

Pours 2 Shots Espresso - 60mL then automatically stops.



Steam Light

Fully illuminated when ready to steam.
 Flashes when warming up to steam temperature & when cooling down (purging water) to coffee temperature.



Steam

Use to steam & texture milk.



Hot Water

Pours 200mL then automatically stops. Use for long black coffee; & hot drinks such as tea, instant soups & to heat your cups prior to making espresso.

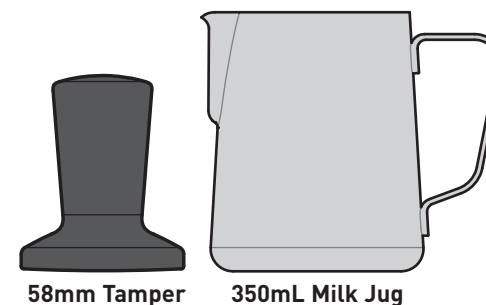

Features of your Sunbeam Mini Barista

Thermoblock Fast Heating System



The thermoblock ensures **quick heat up**, and a precise water temperature for the best coffee extraction, and milk texturing.

The thermoblock is fitted with a **PID controller** which continually monitors the water temperature to ensure water is always delivered to the coffee grinds at the precise temperature needed.

An espresso is made with hot rather than boiling water. The thermoblock heats the water so that the **espresso extracts at 92°C** (just below boiling point) for optimum extraction of oils from the coffee grinds. Temperatures above this will burn the grinds resulting in a bitter taste.

15 BAR Italian Pump



The thermoblock works in conjunction with the pump to deliver the correct water temperature at the **correct pressure** for complete extraction of oils, coffee solids and aroma.

The 15 BAR pump is fitted with a **pressure relief system**, to limit the pressure to 15 bar (for protection from over-pressure). After extraction, when the DIAL is returned to the vertical READY position, any remaining pressure will be released (purged) into the Drip Tray.

Pre-Infusion

Small amounts of water are released onto the tamped coffee grinds prior to the steady flow of water, for a richer flavoured espresso.

Italian Crema System

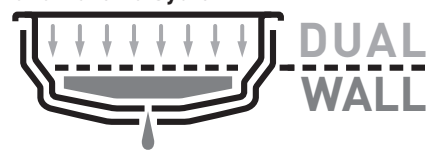

Dual Wall Filter Baskets create additional back pressure creating a subtle aeration for a great espresso extraction and **steady pour**. They ensure a rich velvety espresso with a signature layer of golden crema.

Dual Wall Filter Baskets are designed for use with pre-ground grinds, however they can also be used with freshly ground grinds.

Auto Shot Volumetric Control



Auto Shot is the easiest way to create a great espresso. Just select ONE or TWO CUP on the DIAL, and it **pours just the right amount**, then automatically stops.

Café 58mm Group Head & Handle

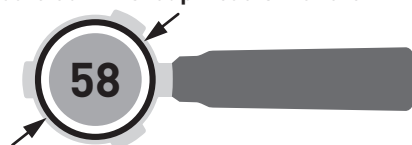

The Group Head and the Group Handle are **commercial sized**, 58mm, just like your local café.

The larger 58mm Group Handle holds more coffee grinds, resulting in a true café tasting coffee. The wider size ensures the grinds are more **evenly spread** and easier to fill, for improved flavour extraction.

The larger 58mm Filter Baskets allow a **more consistent grind compaction**, resulting in a better tasting coffee, and an easier to empty spent coffee cake.

Before First Use of the Mini Barista Espresso Machine

Step 1. Remove Packaging

Ensure all packaging has been removed.

Important: Remove the red Plug found at the base of the Water Reservoir.

Step 2. Position Machine

Ensure the espresso machine is always positioned onto a dry, stable, flat horizontal bench top.

Step 3. Wash Parts

Wash the 8 parts listed below in warm water with a mild detergent.

- Stainless Steel Milk Jug
- Stainless Steel Drip Tray Grill
- Stainless Steel One Cup Filter Basket
- Stainless Steel Two Cup Filter Basket

Important: Below 4 parts are **NOT DISHWASHER SAFE**:

- Group Handle
- Drip Tray
- Tamper
- Water Reservoir

Rinse and dry each part thoroughly then place on the machine.

Step 4. Prime the Machine

Important: Priming must be completed prior to first use.

• Fill Water Reservoir

- Push back the Lid to open.
- Fill with room temperature water.

or

- Remove the reservoir by opening the Lid, & lifting upwards using the Handle inside.
- Fill with room temperature water from the tap.
- Replace the Water Reservoir firmly into position & close the Lid.

Note: Make sure that the Water Reservoir is clean and free of any debris, as any fine particles can block the water flow.

• Power

Ensure that:

- DIAL is in the vertical READY position.
- Insert the Power Plug into a 230-240V AC power outlet & turn the power on.
- Press the ON/OFF BUTTON to start the machine.

The ON/OFF LIGHT will illuminate & pulse to indicate it is warming up.

When both the ON/OFF & READY LIGHTS are fully illuminated, the machine is ready.

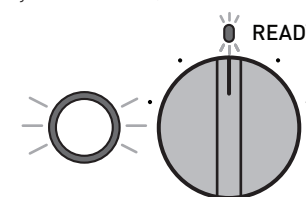

• Insert Group Handle

- Place the Two Cup Filter Basket in the Group Handle.
- Insert the Group Handle into the Group Head.

To ensure that the Group Handle is in the correct position, align the Group Handle with the 'INSERT' position located on the left of the Group Head.

Insert the Group Handle flat against the Group Head, then turn the Group Handle right all the way to the centre position.

• Prime the Machine

- Turn the DIAL to the TWO CUP setting & allow the water to run through.

READY LIGHT flashes when DIAL needs to be returned to the vertical position.

- Do this once more.

Now the machine should be thoroughly primed and ready to use.

If water does not run through the Group Head, contact Sunbeam Customer Care. Details are on the back page.

Coffee Making Guide for the Mini Barista Espresso Machine

1. Start Up

Check for water in reservoir.

Turn on.

ON/OFF LIGHT pulses = Heating up.

ON/OFF & READY LIGHTS are both fully illuminated = Ready.

2. Warm Cup

Warm cup & Tamper on top Warming Plate.

Place cup on benchtop & position Steam Wand.

Turn DIAL to HOT WATER.

Half fill cup with hot water.

Return DIAL to vertical position.

3. Select Filter Baskets

Select either:

- One Cup Filter Basket.
- Two Cup Filter Basket.

4. Warm Group Head, Handle & Filter Basket

Turn DIAL to ONE CUP position.

Hold Group Handle under Group Head while water flows.

READY LIGHT flashes = return DIAL.

Coffee Making Guide for the Mini Barista Espresso Machine

5. Dry Basket

Wipe Filter Basket with a dry cloth.

6. Dose & Tamp

Dose the Filter Basket with grinds.

Evenly tamp (press) grinds to level indicated.

Wipe edges to clear any excess grinds.

7. Insert Group Handle into Group Head

ALIGN & INSERT

TURN

CENTRE

Keep Group Handle flat, insert into Group Head.

Turn Group Handle.

Group Handle should be in the centre position.

8. Position Cup

Empty hot water from cup.

Position cup on Drip Tray, under Group Handle.

9. Extraction

Turn DIAL to either:

- One Cup - 30mL pour.
- Two Cup - 60mL pour.

Extraction begins & will automatically stop.

READY LIGHT flashes = Pour finished. Return DIAL.

Leave Group Handle in Group Head, until after milk texturing.

Coffee Making Guide for the Mini Barista Espresso Machine

10. Prep Milk Jug 11. Before Texturing Milk



Fill Jug with cold milk to just below the bottom of the spout.

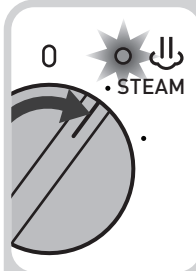

Turn DIAL to STEAM. STEAM LIGHT flashes = Warming up.

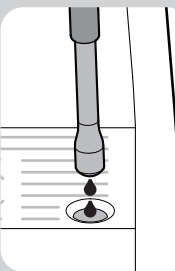

Some water may come out of Steam Wand.

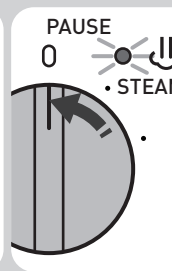

STEAM LIGHT is ON = Steam Ready. Pause steam by returning DIAL.

Pro Tip: For best milk texturing results, ensure steam has first warmed up (STEAM LIGHT fully ON). You will hear the Pump start.

12. Start Texturing Milk



Insert Steam Wand Tip just below the surface of the milk.

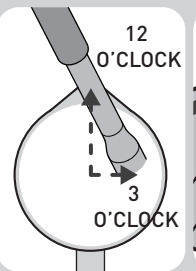

Steam Wand position:
- Arm at 12 o'clock.
- Tip at 3 o'clock.

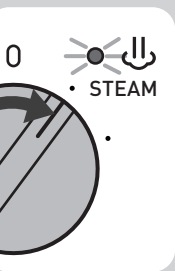

Turn DIAL back to STEAM position to start texturing milk.



Texturing makes a smooth hissing noise.

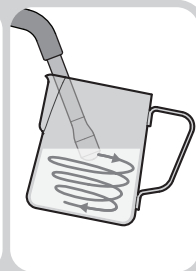

Check milk is moving in a whirlpool action.

13. Milk Texturing

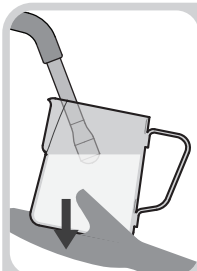

As milk level rises, lower Jug to keep Tip just below surface.



When desired micro-foam achieved, immerse Steam Wand half way.

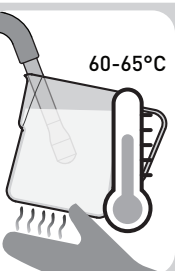

Milk ready when Jug is too hot to touch for 3 secs.

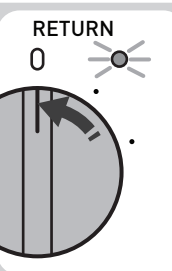

Return DIAL to vertical position.



Remove Jug from Steam Wand.

Coffee Making Guide for the Mini Barista Espresso Machine

14. Purge and Clean Steam Wand

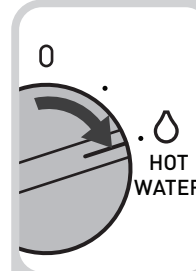

Turn DIAL to HOT WATER for 1-2 secs.

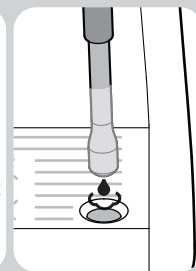

Milky water will come out of Steam Wand.

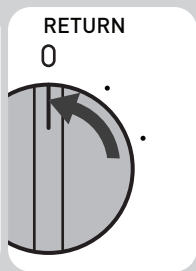

Return DIAL to the vertical position.



Wipe Steam Wand & Tip with a damp cloth.

Pro Tip: To keep optimum Steam Wand performance, always purge & clean the Steam Wand after texturing milk.

15. Milk Finishing Touches

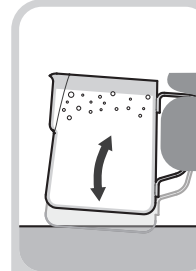

Tap Jug to release larger air bubbles.

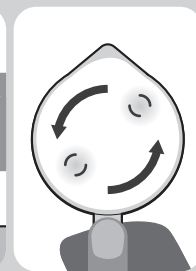

Swirl Jug to blend milk & create a silky texture.

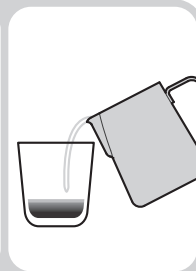

Pour milk in one steady stream.

16. Thermoblock Auto Purge

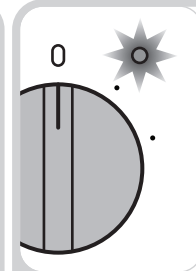

When cooling to espresso temp, STEAM LIGHT flashes & water purges into Drip Tray. Keep Drip Tray in place.



17. Cleaning Up

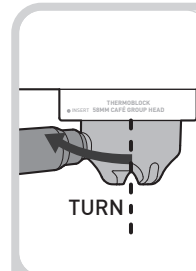

Turn Group Handle & remove from Group Head.

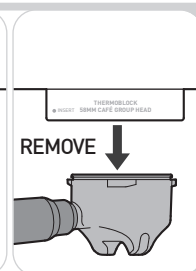

REMOVE



REMOVE spent cake from Group Handle.



REMOVE

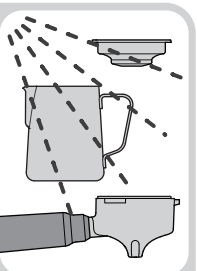

Wash parts with warm water.

Tips for Making the Perfect Cup

The way the espresso pours will tell you everything. Look out for:

1. Extraction Time

Extraction time provides a good indicator of the quality of the pour. The optimum time per shot varies between different bean types and between freshly & pre-ground coffee grinds. However, in general, the time will be between 20-30 seconds for both One & Two Cup shots.

2. Type of Extraction

• Optimum Extraction

A quality pour has a steady flow with a consistency similar to that of warm honey. The resulting crema is dark golden. The sweetest flavours and oils have been extracted creating a rich tasting espresso.

• Under Extraction

The pour is quick and light in colour, the resulting crema is thin with a creamy light brown colour which quickly dissipates. This occurs when too little of the essential oils, flavours and colours from the coffee grinds have been extracted. This creates a sour tasting espresso.

• Over Extraction

There may be no pour, or it may be slow and drip throughout the entire pour. The resulting crema is very dark. This occurs when too much of the essential oils, flavours and colours from the coffee grinds have been extracted. This creates a bitter tasting espresso.

3. Look for Colour Change

The optimum shot contains 3 elements:

Heart: At the base - starts out dark brown.

Body: Blends with the heart - becomes a rich caramel with reddish reflections.

Crema: The layer on top of the body - dark golden.



4. Grinds

You may need to vary the coffee grind size when using different beans.

Important: Ensure beans or pre-ground grinds are fresh. Old pre-ground grinds and old beans, no matter the grind size, will not produce a good tasting espresso.

5. Grind Dosage

For best results, grind dosage should remain consistent:

One Cup: 10-12g - about 2 Tbsp.

Two Cups: 20-22g - about 1/4 metric cup.

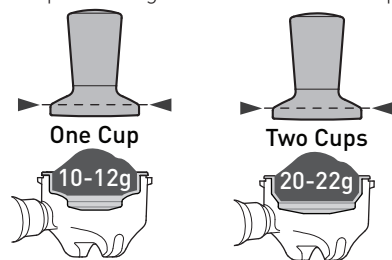

Note: When using pre-ground bagged grinds, try using a 2 step dose & tamp method: Dose in half the grinds then tamp & repeat.

6. Tamp Force

For best results, evenly tamp (press) grinds to the level indicated.

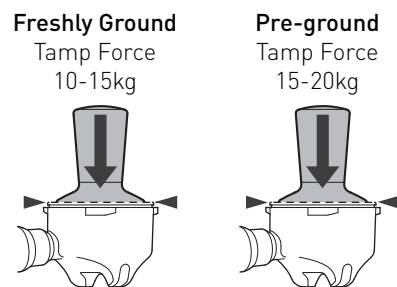

Note: Isolating changes to Grind Size & Tamp Force will assist in producing a consistent taste every time.

Tips for Making the Perfect Cup

7. Filter Baskets

• Dual Wall Filter Baskets

Supplied with the Mini Barista, these work well with both pre-ground bagged grinds & freshly ground grinds.

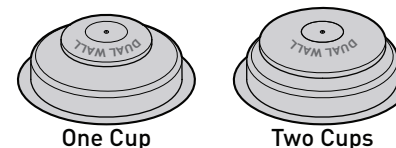

• Single Wall Filter Baskets

Are available for purchase from Sunbeam. Details are on the back page.

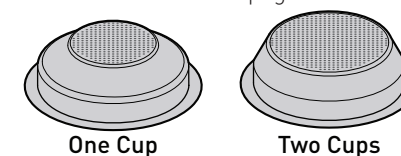

Note: If using Single Wall Filter Baskets (not supplied with the Mini Barista), pre-ground bagged grinds are too coarse.

Extraction Guide

There are extraction variations from bean to bean, and everyone's taste is different. Use the below as a guide to improve your espresso technique, so it's just right for you.

	UNDER EXTRACTION	OPTIMUM EXTRACTION	OVER EXTRACTION
Pour ^	Quick flow Under 15 sec	Steady flow 20-30 sec	No flow-drips Over 35 sec
Colour	Pale brown Crema-light brown	Rich caramel Crema-dark golden	Very dark brown Crema-dark brown
Taste	Sour, Acidic, Watery	Rich, Sweet, Vibrant	Bitter, Dry, Grainy
Grind ^^	Too coarse Use a finer grind	Just right	Too fine Use a coarser grind
Dosage	Not enough grinds Use more grinds	One Cup: 10-12g Two Cups: 20-22g	Too many grinds Use less grinds
Tamp	Not enough tamp force Tamp firmer*	Just right-firm pressure 10-15Kg of force**	Too much tamp force Tamp lighter

^ When using pre-ground bagged grinds, use the Dual Wall Filter Baskets.

^^ Ensure beans or pre-ground grinds are fresh. Old pre-ground grinds & old beans, no matter the grind size, will not produce a good tasting espresso.

* When using pre-ground bagged grinds, try using a 2 step dose & tamp method: Dose in half the grinds then tamp & repeat.

** When using pre-ground bagged grinds try tamping a little harder, 15-20Kg of force.

Remember practice makes perfect.

Visit our Coffee Hub to see more - sunbeam.com.au/coffeehub

Tips for Milk Texturing

Milk texturing is the steaming of milk.

Key Elements to Textured Milk

The steam only heats the milk. The milk also needs to be aerated (add air) to create the micro-foam, and needs to be blended well together. Milk that has been textured correctly has been heated to between 60-65°C, and has a thick, rich micro-foam with a silky sheen. It's all about the temperature, positioning of the Steam Wand and when you move the Milk Jug.

1. Fill Milk Jug

Add cold milk around 4°C into a chilled clean Stainless Steel Jug. Fill to the bottom of the spout.

Note: The volume of milk will increase or 'stretch' during texturing, so don't overfill the Jug.



A larger capacity Milk Jug is available for purchase from Sunbeam. Details are on the back page.

2. Steam Warm Up

For best milk texturing results every time, ensure steam has warmed up before texturing milk. Steam is ready when STEAM LIGHT is fully ON. You will also hear the Pump start.

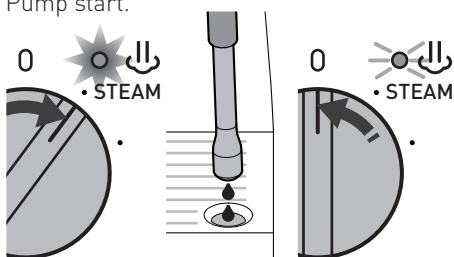

3. Position

Place the Steam Wand Arm in the Jug spout at the 12 o'clock position, with the Steam Wand Tip in the milk at the 3 o'clock position. Keep the Steam Wand Tip just under the surface of the milk. This will create a whirlpool action.

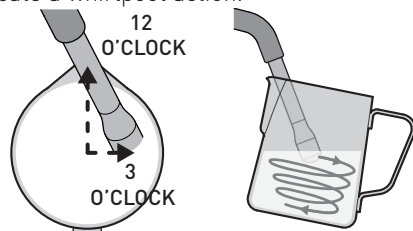

4. Sound

How air is introduced to the milk determines the consistency of the foam. If large gulps of air are added to the milk, the foam will have large bubbles. Introducing air to the milk in a controlled, gentle fashion indicated by a gentle hissing sound, will ensure the milk has fine aerated micro-foam.

Pro Tip: Milk Texturing Sounds

- Screeching - Tip too deep, lower Jug.
- Smooth Hissing - Just right for latte.
- Gurgling - Tip not deep enough, raise Jug.

5. Keeping Steam Tip Position

As the steam heats and textures the milk, the milk will stretch causing the level of the milk in the Jug to rise. As this happens follow the level of the milk by lowering the Jug, keeping the Steam Wand Tip just below the surface.

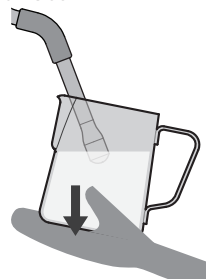

Tips for Milk Texturing

6. Amount of Foam

Create the amount of micro-foam you want. Cappuccinos traditionally have more micro-foam than a flat white. (See Coffee Styles on the next page)

7. Immerse Tip

After you have created the amount of foam you want, immerse the Steam Wand half way down the milk level. This heats all the milk and pulls in milk instead of air. This ensures the milk and foam is blended together, making it denser and smoother.



8. Correct Temperature

An indicator that correct milk temperature has been reached is when the Jug can only be held for approximately 3 seconds.

Pro Tip: Milk Temperature

- Under - If not heated long enough, it will be warm with little texture.
- Optimum - between 60-65°C.
- Over - If heated for too long it will start to boil around 72°C, and will have a burnt taste with all texture lost.

9. Tap & Swirl the Jug

Gently tapping the Jug on the benchtop helps release larger trapped air bubbles.

Swirling helps the milk and froth to combine for an even consistency and a silky appearance.

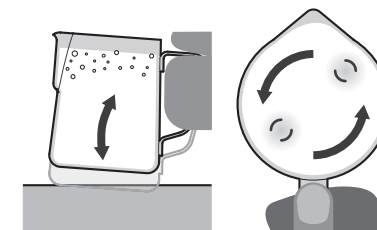

10. The Finishing Touches

Pour from the Milk Jug into your cup in one steady motion.

11. Purging the Steam Wand

After turning the DIAL to the vertical READY position and removing the Jug from the Steam Wand, place the Steam Wand over the Drip Tray and purge the Steam Wand to remove any milk that has been sucked up.

To purge turn the DIAL to the HOT WATER position for a few seconds, then return the DIAL to the vertical READY position.

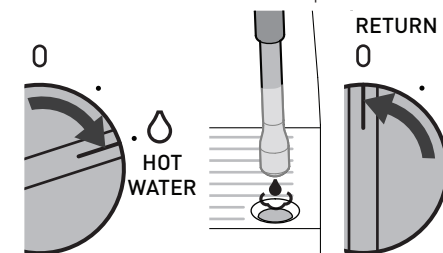

12. Wipe Steam Wand

Wipe the Steam Wand Arm and Tip with a clean damp cloth to remove any milk residue.



Remember practice makes perfect.
Visit our Coffee Hub to see more - sunbeam.com.au/coffeehub

Coffee Styles to Try



Espresso (Short Black)

Espresso is a concentrated, full bodied coffee with a stable layer of 'crema' on top. An espresso is the foundation of all café coffee.

- Espresso glass (90mL)
- Single or double shot of espresso (30mL-60mL)



Ristretto

A ristretto is an extremely short espresso, distinguished by its intense flavour and aftertaste.

- Espresso cup (30mL)
- Half a single shot of espresso (15mL)

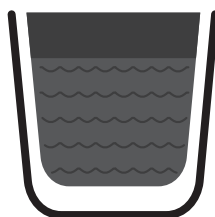

Long Black (Americano)

A standard espresso with hot water added. The hot water is added first so that the 'crema' is maintained.

- Cup (190mL)
- Hot Water (to preference)
- Single or double shot of espresso (30mL-60mL)

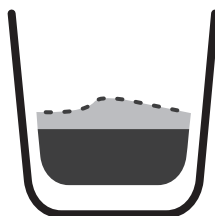

Con Panna

Con Panna, Italian for 'with cream', made up of an espresso topped with lightly whipped cream. It can also be dusted with cinnamon or drinking chocolate.

- Cup (190mL)
- Single or double shot of espresso (30mL-60mL)
- Lightly whipped cream - dusted cinnamon.

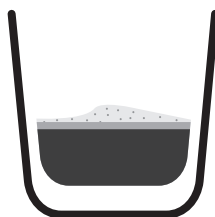

Macchiato

Macchiato, Italian for 'to stain or mark'. Traditionally served as a standard espresso with a dash of cold or textured milk and a small dollop of textured foam into the middle of the 'crema'.

- Espresso glass (90mL)
- Single or double shot of espresso (30mL-60mL)
- Dash of cold or textured milk & small dollop of textured foam.

Coffee Styles to Try



Flat White

An espresso with textured milk and a thin layer of textured foam milk on top. The wider cup will create the slim layer of foam, the signature of the flat white.

- Wide cup (190mL)
- Single or double shot of espresso (30mL-60mL)
- Textured milk & foam.

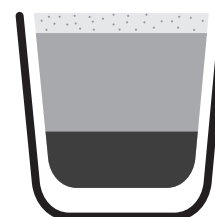

Latte

An espresso with textured milk and a finger width layer of textured foam milk on top. The narrower cup will create the thicker layer of foam.

- Glass or Cup (220mL)
- Single or double shot of espresso (30mL-60mL)
- Textured milk & foam.

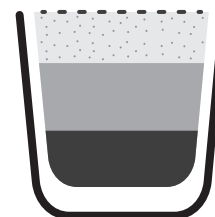

Cappuccino

An espresso with 1/3 steamed textured milk, topped with 1/3 creamy foam and a dusting of chocolate.

- Cup (190-240mL)
- Single or double shot of espresso (30mL-60mL)
- 1/3 Textured milk, 1/3 textured foam - dusted with chocolate.

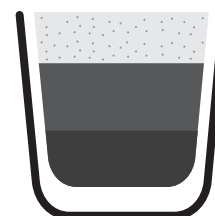

Mocha

Made in a similar way to a cappuccino but with the addition of drinking chocolate. Simply stir the chocolate into the espresso prior to adding the steamed textured milk and foam.

- Cup or tall glass (190-240mL)
- Single or double shot of espresso (30mL-60mL)
- Drinking chocolate (to preference)
- 1/3 Textured milk, 1/3 textured foam.

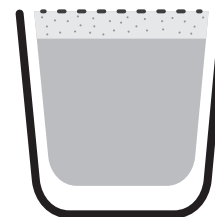

Babyccino

Steamed textured milk with a layer of foamed milk. It can also be dusted with chocolate.

- Small cup (90mL)
- No shot of espresso
- Textured milk & textured foam - dusted with chocolate.

Shot Volume Programming

The Mini Barista Espresso Machine features Auto Shot Volumetric Control. It pours just the right amount of espresso then automatically stops.

One Cup- Pours 1 Shot Espresso- 30mL
Two Cup- Pours 2 Shots Espresso- 60mL

You can adjust the pour volume to suit how you like your coffee.

Preparing for Shot Programming

• Check Water Reservoir

Ensure there is enough water in the Water Reservoir.

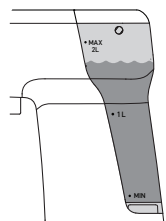

• Power

Ensure that:

- Operating DIAL is in the vertical READY position.
- The Power Plug is inserted into the outlet and turned on.
- The machine is ON and in the Ready state.

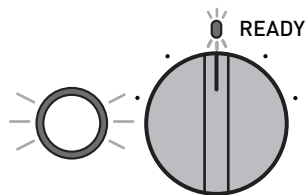

Important: If a Shot Volume Program isn't started within 1 minute of entering Shot Programming, the machine will exit back to the Ready state.

One Cup - Shot Volume Program

- Press & hold the ON/OFF BUTTON for 4 seconds or until a flashing light combination between the ON/OFF & READY LIGHTS begins.

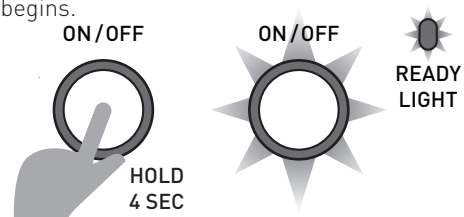

- Insert a One Cup Filter Basket into the Group Handle & fill with coffee grinds then tamp. Place in the Group Head.

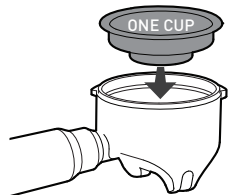

- Turn the DIAL to the ONE CUP position. The ON/OFF & READY LIGHTS will continue to flash once every few seconds.

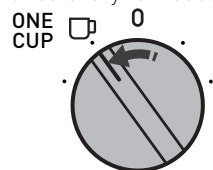

Espresso will start to pour.

- When you reach your desired 1 Shot Volume, return the DIAL to the vertical READY position.

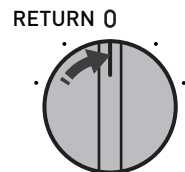

The espresso pour will stop.

The new 1 Shot Volume has been programmed. The Programming Mode has finished and returned to the Ready state.

Shot Volume Programming

Two Cup - Shot Volume Program

- Press & hold the ON/OFF BUTTON for 4 seconds or until a flashing light combination between the ON/OFF & READY LIGHTS begins.

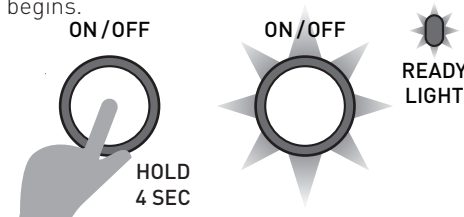

- Insert a Two Cup Filter Basket into the Group Handle & fill with coffee grinds then tamp. Place in the Group Head.

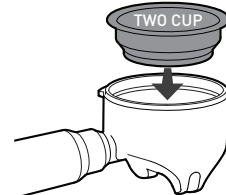

- Turn the DIAL to the TWO CUP position. The ON/OFF & READY LIGHTS will continue to flash once every few seconds.

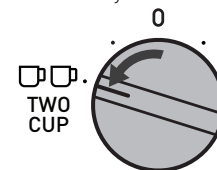

Espresso will start to pour.

- When you reach your desired 2 Shot Volume, return the DIAL to the vertical READY position.

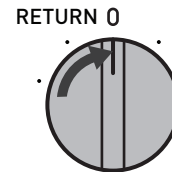

The espresso pour will stop.

The new 2 Shot Volume has been programmed. The Programming Mode has finished and returned to the Ready state.

Restore Default One & Two Cup - Shot Volumes

- Press & hold the ON/OFF BUTTON for 4 seconds or until a flashing light combination between the ON/OFF & READY LIGHTS begins.

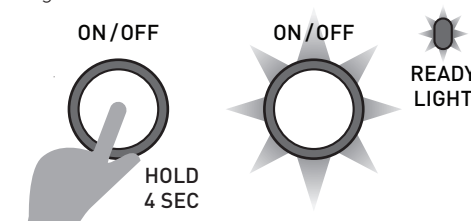

- Turn the DIAL to the HOT WATER position.

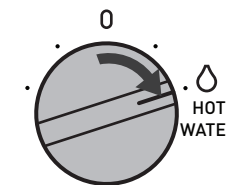

All LIGHTS will flash together 3 times. The Default Volumes has been restored. The Programming Mode has finished.

- Return the DIAL to the vertical Ready position.

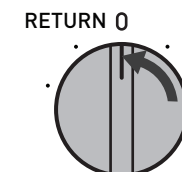

Care & Cleaning

The espresso making process involves extracting oils out of coffee grinds. Deposits of grinds and oils build up over time affecting the taste of the coffee and operation of the espresso machine.

Purging water through the Group Head and Steam Wand, before and after making each coffee, is the easiest way to keep your machine clean.

(See Operating Guide page 6-9)

Important: Below parts are **NOT DISHWASHER SAFE:**

- Group Handle
- Drip Tray
- Tamper
- Water Reservoir

CAUTION: To prevent damage to the appliance do not use alkaline cleaning agents when cleaning the exterior. Use a soft cloth and a mild detergent.

Cleaning Tablets

Sunbeam Espresso Machine Cleaning Tablets (EM0020) are available for purchase from Sunbeam. Details are on the back page.

Cleaning Drip Tray

Empty the Drip Tray when required, if the red Water Level Indicator appears through the Grill, empty the Drip Tray immediately.

• Weekly

Clean the Drip Tray and Grill with warm water and a little non-abrasive washing up liquid, rinse and dry.

Note: Over time it is normal for the inside of the Drip Tray to be stained by the oils in the coffee grinds.

Cleaning Warming Plate & Exterior

Wipe over the machine with a damp cloth and wipe dry. Do not use alkaline cleaning agents, abrasives or metal scourers, as these will scratch the exterior surface.

Important: Do not immerse the machine in water.

Cleaning Group Handle & Filter Basket

• Every Time

Wash after each use by rinsing them with warm water under the tap.

• Regular Intervals

In warm soapy water using a mild detergent.

Cleaning Group Head

• Every Time

Run water through before making an espresso. (See Operating Guide page 6-9)

• Weekly

- Purge water through by turning the DIAL to the ONE CUP setting.
- Return DIAL when it has finished running.
- Wipe around the inside rim with a damp cloth & brush.

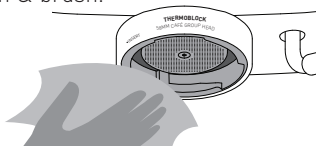

Cleaning Filter Baskets

• 2-3 Months

- Soak the Filter Basket overnight in the Milk Jug with warm water & add one Sunbeam Cleaning Tablet.

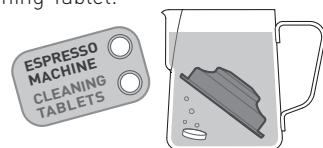

- In the morning rinse the Jug & Filter Basket under running water ensuring all traces of the cleaning tablet has been removed.
- Place Filter Basket into Group Handle (without coffee) & insert into Group Head.
- Turn the DIAL to the ONE CUP setting. Water will pour through.
- Return DIAL to the vertical position.

• Unblocking Filter Baskets

If the Dual Wall Filter Basket becomes clogged with coffee grinds:

- Insert the 'Filter' Cleaning Pin in the exit hole. (Cleaning Pin located in the 'Accessories' storage area under the Drip Tray).

Care & Cleaning

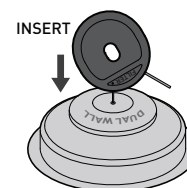

- Place Filter Basket into Group Handle (without coffee) & insert into Group Head.
- Turn the DIAL to the ONE CUP setting. Water will pour through.
- Return DIAL when finished.
- Repeat if needed.

Cleaning Steam Wand

• Every time

- After texturing milk purge the Steam Wand by turning the DIAL to HOT WATER for just 1-2 secs.
- Wipe the Steam Wand with a damp cloth. (See Operating Guide page 9)

• 2-3 Months

- Soak the Steam Wand overnight in the Milk Jug with warm water & add one Sunbeam Cleaning Tablet.



- In the morning remove the Jug & rinse ensuring that all traces of the solution have been removed.
- Wipe Steam Wand & Tip with a damp cloth ensuring that all traces of the cleaning tablet have been removed.
- Run Hot Water through the Steam Wand for 40 secs.

• Unblocking Steam Wand

- Insert the 'Steam' Cleaning Pin up the Steam Wand Tip hole. (Cleaning Pin located in the 'Accessories' storage area under the Drip Tray).
- Run Hot Water through the Steam Wand.

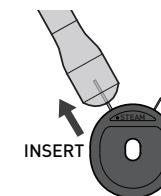

• Steam Wand Remains Blocked:

- Unscrew the Steam Wand Tip & soak overnight in the Milk Jug with warm water & add one Sunbeam Cleaning Tablet.



- In the morning rinse the Jug & Steam Wand Tip under running water ensuring all traces of the cleaning tablet have been removed.
- Use the Cleaning Pin to clean the Steam Tip.
- Screw the Steam Wand Tip back into the Steam Wand Arm.
- Run Hot Water through the Steam Wand for 40 secs.

Group Head Rubber Seal

A rubber seal is located in the Group Head and creates a seal against the Filter Basket when making an espresso.

Important: When your espresso machine is not being used, we recommend that you do not leave the Group Handle inserted into the Group Head, as this will reduce the life of the seal.

Over time this seal loses its elasticity and may require replacement. The seal may need replacing when watery espresso leaks from around the Group Head, or if the Group Handle feels loose when fully rotated to the centre position.

Note: Contact Sunbeam should you think that the Group Head seal needs replacing. Do not attempt to change the seal without first consulting Sunbeam.

Descaling: Group Head & Steam Wand

After continued use, your espresso machine may develop a build-up of mineral deposits, and therefore require occasional 'descaling'.

We recommend descaling your machine every 4-6 months, although this period will depend on the hardness of water and frequency of use.

Descaling Solution

You have 3 options:

A. Sunbeam Espresso Machine Descaling Tablets (EM0010).

or

B. Sunbeam Liquid Descaler (KE0100).

A & B Descaling options are available for purchase from Sunbeam. Details are on the back page.

or

C. White vinegar & warm water.

Descaling Program

The Descaling Program takes approximately 10 minutes to complete.

Important: If the Descaling Program is not completed or stopped part way through any of the Descaling Steps, then you will need to start the Descaling Program again from the beginning.

Preparing for Descaling

• Fill Water Reservoir with Solution

A. Fill Water Reservoir with 1 Litre of warm water add one Sunbeam Descaling Tablet. Allow tablet to fully dissolve.

or

B. In an empty Water Reservoir add half a cap full of Sunbeam Liquid Descaler. Fill Water Reservoir with 1 Litre of warm water. Allow solution to mix thoroughly.

or

C. In an empty Water Reservoir add 1½ tablespoons of white vinegar. Fill Water Reservoir with 1 Litre of warm water. Allow solution to mix thoroughly.

- Place the Water Reservoir into position.

• Place Containers

Place a 1 Litre container under Group Head and another 1 Litre container under the Steam Wand.

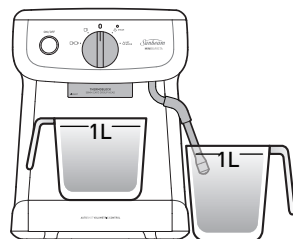

• Power

Ensure that:

- Operating DIAL is in the vertical READY position.
- The Power Plug is inserted into the outlet and turned on.
- The machine is ON and in the Ready state.

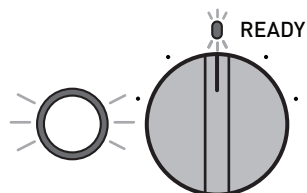

• Access the Descaling Program

- Press & hold the ON/OFF BUTTON for 4 seconds or until a flashing light combination between the ON/OFF & READY LIGHTS begins.

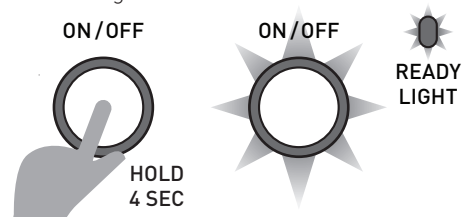

Important: If Descaling Step 1 isn't started within 1 minute of entering the Descaling Program, the machine will exit the Descaling Program, and go back to the Ready state.

Important: The Descaling Program can be exited at any point if the DIAL is returned to the vertical Ready position.

Descaling: Group Head & Steam Wand

Step 1. Steam Wand Descaling

- To start the Descaling Program turn the DIAL to the STEAM position.

The ON/OFF & STEAM LIGHTS will now start a flashing combination once every few seconds.

The Pump will start and hot water will run from the Steam Wand. Over a 2 minute period the Pump will make different noises.

When the hot water has stopped being released from the Steam Wand, this step has finished.

The flashing light combination will change to the ON/OFF & READY LIGHTS.

- Move to **Step 2**.

Important: In-between each of the Descaling Steps there is a maximum of 5 minutes allowed to start the next step before the Descaling Program will exit.

Step 2. Group Head Descaling

- To continue turn the DIAL directly to the ONE CUP position (do not stop at the ready position).

The ON/OFF & READY LIGHTS will continue a flashing combination once every few seconds.

The Pump will start and hot water will run from the Group Head. Over a 2 minute period the Pump will make different noises.

When the hot water has stopped being released from the Group Head, this step has finished.

The flashing light combination will change to the ON/OFF & STEAM LIGHTS.

- Move to **Preparing for Purge** section.

Preparing for Purge

The Steam Wand and Group Head now need to be purged clean with fresh water to remove descaling solution.

• Rinse Water Reservoir

Remove the Water Reservoir & rinse thoroughly under running water, ensuring that all traces of the descaling solution have been removed.

• Fill Water Reservoir

Fill the Water Reservoir to the 'MAX' line with clean water and replace.

• Empty Containers

Empty water from the containers and replace.

- Move to **Step 3**.

Step 3. Steam Wand Purge

- To continue turn the DIAL directly to the STEAM position (do not stop at the ready position).

The ON/OFF & STEAM LIGHTS will continue a flashing combination once every few seconds.

The Pump will start and hot water will run from the Steam Wand. Over a 2 minute period the Pump will make different noises.

When the hot water has stopped being released from the Steam Wand, this step has finished.

The flashing light combination will change to the ON/OFF & READY LIGHTS.

- Move to **Step 4**.

Step 4. Group Head Purge

- To continue turn the DIAL directly to the ONE CUP position (do not stop at the ready position).

The ON/OFF & READY LIGHTS will continue a flashing combination once every few seconds.

The Pump will start and hot water will run from the Group Head. Over a 2 minute period the Pump will make different noises.

When the hot water has stopped being released from the Group Head, the Descaling Program has finished.

Complete

The ON/OFF LIGHT will be fully illuminated and the READY LIGHT will flash to show the Descaling Program has finished.

- Return the DIAL to the vertical READY position.

- Empty water from the containers.

Troubleshooting Guide

PROBLEM	Possible Cause	What To Do
Group Handle comes off during espresso pour.	Group Handle is not attached correctly, or has not been tightened sufficiently.	Ensure all three tabs of the Group Handle are fully inserted into the Group Head, & rotated to the centre position. See Operating Guide Section, page 7.
	Coffee grind is too fine.	Change to a coarser grind.
Espresso squirts out of the Group Head during pour	Coffee grinds tamped too hard.	Tamp the grinds more lightly.
	Top edge of filter is not free of coffee grinds.	Clean around the top edge of the filter and wipe the Group Head clean.
Espresso trickles down the side of the Group Handle	The Group Head is dirty.	Wipe with a damp cloth. Clean the seal including the bayonet corner areas with a brush to remove grinds.
	Group Head rubber seal is damaged or worn.	Contact Sunbeam Customer Care. Details are on the back page.
No coffee pours	No water in the Water Reservoir.	Fill reservoir with water. Run water through the machine without a Filter Basket to ensure it is fully primed.
	Group Head may be blocked.	See Descaling Section, pages 20-21.
	The Dual Wall Filter Baskets may be blocked.	Use the Cleaning Pin to unblock the Filter Basket.
	The coffee grounds are too fine or tamped down too hard.	Empty the Filter Basket and rinse under water to clean. Wipe the group head with a cloth. Refill the filter with grinds and tamp.
Coffee pours out in drips (Over Extracted)	Grinds are too fine.	Change to a coarser grind.
	Coffee tamped too hard.	Tamp the grinds more lightly.
	Machine has scale build up.	See Descaling Section, pages 20-21.
Espresso does not have any Crema (Under Extracted)	Beans are old or pre-ground grinds are dry.	Use fresh beans and grinds. Be sure to store pre-ground grinds in an airtight container.
	Grinds not compacted enough.	Tamp more firmly.
	Grinds too coarse.	Use a finer grind coffee.
Uneven cup filling	Uneven tamping or obstruction in the pouring spouts.	Ensure coffee is tamped evenly and check there is nothing obstructing the pouring spouts.
Spent Coffee Cake is wet	Dual Wall Filter Baskets can keep the Coffee Cake wet.	Keep Group Handle in Group Head until milk texturing is finished. This will give more time for the water to dissipate.

Troubleshooting Guide

PROBLEM	Possible Cause	What To Do
Espresso tastes burnt	Type of coffee being used.	Try different brands of coffee.
	Using steam function just before pouring an espresso shot.	Allow time for the thermoblock to purge steam and cool down before pouring a shot of espresso. The STEAM LIGHT should have finished flashing & the READY LIGHT should be fully illuminated.
Coffee is too cold	Milk may not be heated enough.	Ensure that milk is heated properly during texturing, but be sure not to heat too much and boil the milk. See Milk Texturing Section pages 12-13.
No steam from the Steam Wand	Steam Wand Tip is blocked.	See Care & Cleaning, pages 18-19.
	No water in the Water Reservoir.	Fill reservoir with water. Run Hot Water through the Steam Wand to ensure water flows.
Not enough froth when texturing	Milk may not be fresh.	Ensure the milk being used is fresh.
	Milk temperature is too warm.	Ensure you start texturing with milk that is around 4°C.
	Type of Jug being used.	For best texturing results use a chilled Stainless Steel Milk Jug.
	Milk has been boiled.	Start again with fresh, chilled milk. Heat till the Jug can only be held for approximately 3 second, 60-65°C.
	The milk is making bubbles rather than micro-foam.	Ensure the Steam Wand Tip is positioned correctly. It should be just below the surface of the milk. Tap the Jug on the benchtop when finished to release larger trapped air bubbles.
Pump makes an unusually noise	Milk is not taking in enough air.	Keep the Steam Wand Tip just under the surface of the milk. This will help to introduce air to the milk to create micro-foam.
	No water in reservoir.	Fill the Water Reservoir.
	Water Reservoir not correctly positioned.	Place the Water Reservoir firmly into the back of the unit.
	Red Plug from the packaging may still be inserted.	Remove the red Plug found at the base of the Water Reservoir.

If this guide does not solve your query, contact Sunbeam Customer Care. Details are on the back page.

Warranty



This Sunbeam product is covered by a 12 month replacement or repair warranty, which is in addition to your rights under the Australian Consumer Law (if your product was purchased in Australia) or New Zealand Consumer Guarantees Act (if your product was purchased in New Zealand).

Upon receipt of your claim, Sunbeam will seek to resolve your difficulties or, if the product is defective, advise you on how to obtain a replacement or refund.

To assist us in managing warranty claims, we recommend you register your product as soon as practicable after purchase by creating a MySunbeam account on our website and uploading a copy of your original receipt.

In order to make a claim under our warranty, you must have the original proof of purchase documentation for the product and present it when requested (if not already uploaded to our website).

Should your product develop any defect within 12 months of purchase because of faulty materials or workmanship, we will replace or repair it, at our discretion, free of charge. A product presented for repair may be replaced by a refurbished product of the same type rather than being repaired. Refurbished parts may be used to repair the product.

Our replacement or repair warranty only applies where a defect arises as a result of faulty material or workmanship during the warranty period. Your warranty does not cover misuse or negligent handling (including damage caused by failing to use the product in accordance with this instruction booklet), accidental damage, or normal wear and tear.

Your warranty does not:

- cover freight or any other costs incurred in making a claim, consumable items, accessories that by their nature and limited lifespan require periodic renewal (such as filters and seals) or any consequential loss or damage; or

- cover damage caused by:
 - power surges, power dips, voltage supply problems, or use of the product on incorrect voltage;

- servicing or modification of the product other than by Sunbeam or an authorised Sunbeam service centre;
- use of the product with other accessories, attachments, product supplies, parts or devices that do not conform to Sunbeam specifications; or
- exposure of the product to abnormally corrosive conditions; or

- extend beyond 3 months if the product is used in commercial, industrial, educational or rental applications.

The benefits given to you by our warranty are in addition to other rights and remedies under law in relation to the product.

In Australia our goods come with guarantees that cannot be excluded under the Australian Consumer Law. You are entitled to a replacement or refund for a major failure and for compensation for any other foreseeable loss or damage. You are also entitled to have the goods repaired or replaced if the goods fail to be of acceptable quality and the failure does not amount to a major failure.

Our goods also come with guarantees that cannot be excluded under the New Zealand Consumer Guarantees Act.

If your warranty claim is not accepted, we will inform you and if requested to do so by you, repair the product provided you pay the usual charges for such repair. You will also be responsible for all freight and other costs.

Should your product require repair or service after the warranty period, contact your nearest Sunbeam service centre. For a complete list of Sunbeam's service centres, visit our website or call our customer care line for advice on: 1300 881 861 in Australia, or 0800 786 232 in New Zealand.

Should you experience any difficulties with your product during the warranty period, please contact Sunbeam Customer Care:

Australia
www.sunbeam.com.au
1300 881 861
Suite 1, Level 1,
13 Lord Street,
Botany NSW 2019
Australia

New Zealand
www.sunbeam.co.nz
0800 786 232
Level 6, Building 5,
Central Park,
660-670 Great South Road
Greenlane, Auckland
New Zealand

Espresso Machine Accessories Available for Purchase

CONTACT SUNBEAM CUSTOMER CARE:
AUS: 1300 881 861 NZ: 0800 786 232

58mm Filter Baskets

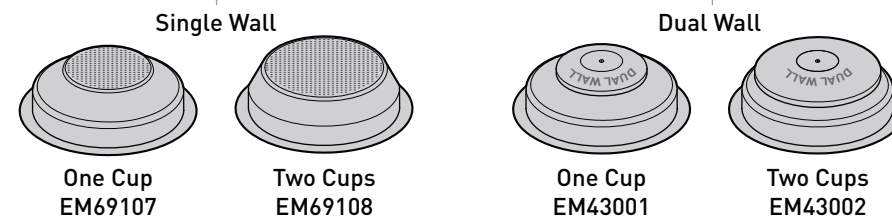

Bang Bang

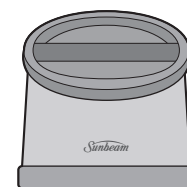

EM0100

Milk Jug

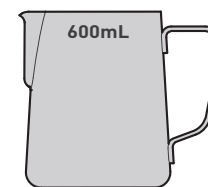

EM0260

Cleaning & Descaling



EM0010

KE0100

EM0020

Sunbeam
MINI BARISTA
ESPRESSO MACHINE

Sunbeam

Need help with your appliance?

Contact our Customer Care Team or visit our website for information and tips on getting the most from your appliance.

AUSTRALIA

Visit: www.sunbeam.com.au
Phone: 1300 881 861
Mail: Suite 1, Level 1,
13 Lord Street,
Botany NSW 2019
Australia

NEW ZEALAND

Visit: www.sunbeam.co.nz
Phone: 0800 786 232
Mail: Level 6, Building 5, Central Park,
660–670 Great South Road,
Greenlane, Auckland



— APPROVED BY —



Newell Australia Pty Ltd | ABN 68 075 071 233
Sunbeam is a registered trade mark.

Due to continued product improvements, product illustrations and photographs in this User Guide may differ slightly from the actual product.

EM4300_20EM1 (ANZ)
GCDS-SUN 1043607-LD